

MGP15N40CL, MGB15N40CL

Preferred Device

Ignition IGBT 15 Amps, 410 Volts

N-Channel TO-220 and D²PAK

This Logic Level Insulated Gate Bipolar Transistor (IGBT) features monolithic circuitry integrating ESD and Over-Voltage clamped protection for use in inductive coil drivers applications. Primary uses include Ignition, Direct Fuel Injection, or wherever high voltage and high current switching is required.

Features

- Ideal for Coil-On-Plug, IGBT-On-Coil, or Distributorless Ignition System Applications
- High Pulsed Current Capability up to 50 A
- Gate-Emitter ESD Protection
- Temperature Compensated Gate-Collector Voltage Clamp Limits Stress Applied to Load
- Integrated ESD Diode Protection
- Low Threshold Voltage to Interface Power Loads to Logic or Microprocessor Devices
- Low Saturation Voltage
- Optional Gate Resistor (R_G)
- Pb-Free Package is Available

MAXIMUM RATINGS (-55°C ≤ T_J ≤ 175°C unless otherwise noted)

Rating	Symbol	Value	Unit
Collector-Emitter Voltage	V _{CES}	440	V _{DC}
Collector-Gate Voltage	V _{CER}	440	V _{DC}
Gate-Emitter Voltage	V _{GE}	22	V _{DC}
Collector Current-Continuous @ T _C = 25°C - Pulsed	I _C	15 50	A _{DC} A _{AC}
ESD (Human Body Model) R = 1500 Ω, C = 100 pF	ESD	8.0	kV
ESD (Machine Model) R = 0 Ω, C = 200 pF	ESD	800	V
Total Power Dissipation @ T _C = 25°C Derate above 25°C	P _D	150 1.0	W W/°C
Operating and Storage Temperature Range	T _J , T _{stg}	-55 to 175	°C

Maximum ratings are those values beyond which device damage can occur. Maximum ratings applied to the device are individual stress limit values (not normal operating conditions) and are not valid simultaneously. If these limits are exceeded, device functional operation is not implied, damage may occur and reliability may be affected.



ON Semiconductor®

<http://onsemi.com>

15 AMPERES
410 VOLTS (Clamped)
V_{CE(on)} @ 10 A = 1.8 V Max

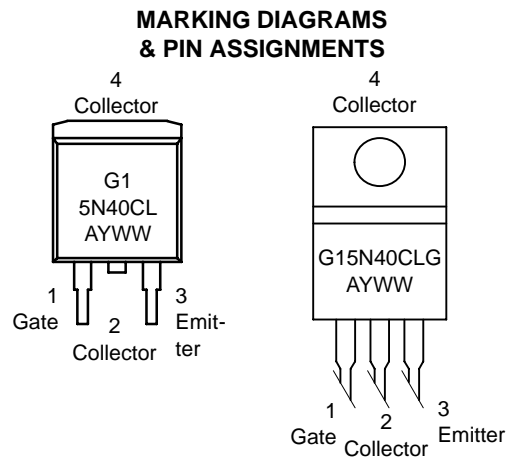
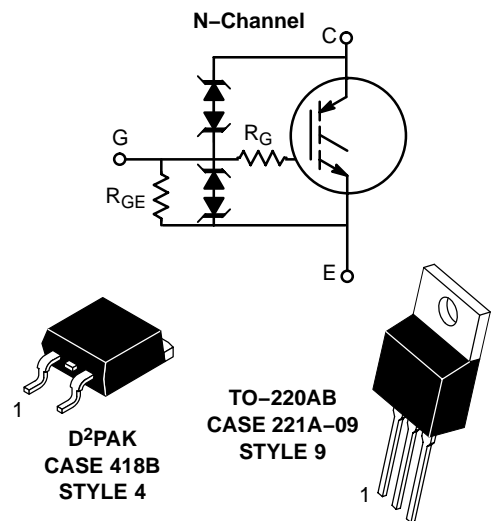

G15N40CL = Device Code
A = Assembly Location
Y = Year
WW = Work Week
G = Pb-Free Package

ORDERING INFORMATION

See detailed ordering and shipping information in the package dimensions section on page 8 of this data sheet.

Preferred devices are recommended choices for future use and best overall value.

MGP15N40CL, MGB15N40CL

UNCLAMPED COLLECTOR-TO-EMITTER AVALANCHE CHARACTERISTICS ($-55^{\circ}\text{C} \leq T_J \leq 175^{\circ}\text{C}$)

Characteristic	Symbol	Value	Unit
Single Pulse Collector-to-Emitter Avalanche Energy $V_{CC} = 50\text{ V}$, $V_{GE} = 5.0\text{ V}$, Pk $I_L = 17.4\text{ A}$, $L = 2.0\text{ mH}$, Starting $T_J = 25^{\circ}\text{C}$ $V_{CC} = 50\text{ V}$, $V_{GE} = 5.0\text{ V}$, Pk $I_L = 14.2\text{ A}$, $L = 2.0\text{ mH}$, Starting $T_J = 150^{\circ}\text{C}$	E_{AS}	300 200	mJ
Reverse Avalanche Energy $V_{CC} = 100\text{ V}$, $V_{GE} = 20\text{ V}$, $L = 3.0\text{ mH}$, Pk $I_L = 25.8\text{ A}$, Starting $T_J = 25^{\circ}\text{C}$	$E_{AS(R)}$	1000	mJ

THERMAL CHARACTERISTICS

Characteristic	Symbol	Value	Unit
Thermal Resistance, Junction-to-Case	$R_{\theta JC}$	1.0	$^{\circ}\text{C/W}$
Thermal Resistance, Junction-to-Ambient	$R_{\theta JA}$	62.5	$^{\circ}\text{C/W}$
TO-220 D ² PAK (Note 1)	$R_{\theta JA}$	50	
Maximum Lead Temperature for Soldering Purposes, 1/8" from case for 5 seconds	T_L	275	$^{\circ}\text{C}$

ELECTRICAL CHARACTERISTICS

Characteristic	Symbol	Test Conditions	Temperature	Min	Typ	Max	Unit
----------------	--------	-----------------	-------------	-----	-----	-----	------

OFF CHARACTERISTICS

Collector-Emitter Clamp Voltage	BV_{CES}	$I_C = 2.0\text{ mA}$	$T_J = -40^{\circ}\text{C}$ to 150°C	380	410	440	V_{DC}
		$I_C = 10\text{ mA}$	$T_J = -40^{\circ}\text{C}$ to 150°C	390	420	450	
Zero Gate Voltage Collector Current	I_{CES}	$V_{CE} = 350\text{ V}$, $V_{GE} = 0\text{ V}$	$T_J = 25^{\circ}\text{C}$	-	1.5	20	μA_{DC}
			$T_J = 150^{\circ}\text{C}$	-	10	40*	
			$T_J = -40^{\circ}\text{C}$	-	0.7	1.5	
Reverse Collector-Emitter Leakage Current	I_{ECS}	$V_{CE} = -24\text{ V}$	$T_J = 25^{\circ}\text{C}$	-	0.35	1.0	mA
			$T_J = 150^{\circ}\text{C}$	-	8.0	15*	
			$T_J = -40^{\circ}\text{C}$	-	0.05	0.5	
Reverse Collector-Emitter Clamp Voltage	$BV_{CES(R)}$	$I_C = -75\text{ mA}$	$T_J = 25^{\circ}\text{C}$	25	33	50	V_{DC}
			$T_J = 150^{\circ}\text{C}$	25	36	50	
			$T_J = -40^{\circ}\text{C}$	25	30	50	
Gate-Emitter Clamp Voltage	BV_{GES}	$I_G = 5.0\text{ mA}$	$T_J = -40^{\circ}\text{C}$ to 150°C	17	20	22	V_{DC}
Gate-Emitter Leakage Current	I_{GES}	$V_{GE} = 10\text{ V}$	$T_J = -40^{\circ}\text{C}$ to 150°C	384	600	1000	μA_{DC}
Gate Resistor (Optional)	R_G	-	$T_J = -40^{\circ}\text{C}$ to 150°C	-	70	-	Ω
Gate Emitter Resistor	R_{GE}	-	$T_J = -40^{\circ}\text{C}$ to 150°C	10	16	26	$k\Omega$

ON CHARACTERISTICS (Note 2)

Gate Threshold Voltage	$V_{GE(th)}$	$I_C = 1.0\text{ mA}$, $V_{GE} = V_{CE}$	$T_J = 25^{\circ}\text{C}$	1.4	1.7	2.0	V_{DC}
			$T_J = 150^{\circ}\text{C}$	0.75	1.1	1.4	
			$T_J = -40^{\circ}\text{C}$	1.6	1.9	2.1*	
Threshold Temperature Coefficient (Neg)	-	-	-	-	4.4	-	$\text{mV}/^{\circ}\text{C}$
Collector-to-Emitter On-Voltage	$V_{CE(on)}$	$I_C = 6.0\text{ A}$, $V_{GE} = 4.0\text{ V}$	$T_J = 25^{\circ}\text{C}$	1.0	1.3	1.6	V_{DC}
			$T_J = 150^{\circ}\text{C}$	0.9	1.2	1.5	
			$T_J = -40^{\circ}\text{C}$	1.1	1.4	1.7*	
		$I_C = 10\text{ A}$, $V_{GE} = 4.0\text{ V}$	$T_J = 25^{\circ}\text{C}$	1.3	1.6	1.9	
			$T_J = 150^{\circ}\text{C}$	1.2	1.5	1.8	
			$T_J = -40^{\circ}\text{C}$	1.3	1.6	1.9*	
		$I_C = 15\text{ A}$, $V_{GE} = 4.0\text{ V}$	$T_J = 25^{\circ}\text{C}$	1.6	1.95	2.25	
			$T_J = 150^{\circ}\text{C}$	1.7	2.0	2.3*	
			$T_J = -40^{\circ}\text{C}$	1.6	1.9	2.2	

1. When surface mounted to an FR4 board using the minimum recommended pad size.

2. Pulse Test: Pulse Width $\leq 300\ \mu\text{s}$, Duty Cycle $\leq 2\%$.

*Maximum Value of Characteristic across Temperature Range.

MGP15N40CL, MGB15N40CL

ELECTRICAL CHARACTERISTICS (continued)

Characteristic	Symbol	Test Conditions	Temperature	Min	Typ	Max	Unit
ON CHARACTERISTICS (continued) (Note 3)							
Collector-to-Emitter On-Voltage	$V_{CE(on)}$	$I_C = 20\text{ A}$, $V_{GE} = 4.0\text{ V}$	$T_J = 25^\circ\text{C}$	1.9	2.2	2.5	V_{DC}
			$T_J = 150^\circ\text{C}$	2.1	2.4	2.7*	
			$T_J = -40^\circ\text{C}$	1.85	2.15	2.45	
		$I_C = 25\text{ A}$, $V_{GE} = 4.0\text{ V}$	$T_J = 25^\circ\text{C}$	2.1	2.5	2.9	
			$T_J = 150^\circ\text{C}$	2.5	2.9	3.3*	
			$T_J = -40^\circ\text{C}$	2.0	2.4	2.8	
Collector-to-Emitter On-Voltage	$V_{CE(on)}$	$I_C = 10\text{ A}$, $V_{GE} = 4.5\text{ V}$	$T_J = 150^\circ\text{C}$	–	1.5	1.8	V_{DC}
Forward Transconductance	gfs	$V_{CE} = 5.0\text{ V}$, $I_C = 6.0\text{ A}$	$T_J = -40^\circ\text{C}$ to 150°C	8.0	15	25	Mhos

DYNAMIC CHARACTERISTICS

Input Capacitance	C_{ISS}	$V_{CC} = 25\text{ V}$, $V_{GE} = 0\text{ V}$ $f = 1.0\text{ MHz}$	$T_J = -40^\circ\text{C}$ to 150°C	–	1000	1300	pF
Output Capacitance	C_{OSS}			–	100	130	
Transfer Capacitance	C_{RSS}			–	5.0	8.0	

SWITCHING CHARACTERISTICS (Note 3)

Turn-Off Delay Time (Inductive)	$t_{d(off)}$	$V_{CC} = 300\text{ V}$, $I_C = 6.5\text{ A}$ $R_G = 1.0\text{ k}\Omega$, $L = 300\text{ }\mu\text{H}$	$T_J = 25^\circ\text{C}$	–	4.0	10	μSec
			$T_J = 150^\circ\text{C}$	–	4.5	10	
Fall Time (Inductive)	t_f	$V_{CC} = 300\text{ V}$, $I_C = 6.5\text{ A}$ $R_G = 1.0\text{ k}\Omega$, $L = 300\text{ }\mu\text{H}$	$T_J = 25^\circ\text{C}$	–	7.0	10	μSec
			$T_J = 150^\circ\text{C}$	–	10	15*	
Turn-Off Delay Time (Resistive)	$t_{d(off)}$	$V_{CC} = 300\text{ V}$, $I_C = 6.5\text{ A}$ $R_G = 1.0\text{ k}\Omega$, $R_L = 46\text{ }\Omega$	$T_J = 25^\circ\text{C}$	–	4.0	10	μSec
			$T_J = 150^\circ\text{C}$	–	4.5	10	
Fall Time (Resistive)	t_f	$V_{CC} = 300\text{ V}$, $I_C = 6.5\text{ A}$ $R_G = 1.0\text{ k}\Omega$, $R_L = 46\text{ }\Omega$	$T_J = 25^\circ\text{C}$	–	13	20	μSec
			$T_J = 150^\circ\text{C}$	–	16	20	
Turn-On Delay Time	$t_{d(on)}$	$V_{CC} = 10\text{ V}$, $I_C = 6.5\text{ A}$ $R_G = 1.0\text{ k}\Omega$, $R_L = 1.5\text{ }\Omega$	$T_J = 25^\circ\text{C}$	–	1.0	1.5	μSec
			$T_J = 150^\circ\text{C}$	–	1.0	1.5	
Rise Time	t_r	$V_{CC} = 10\text{ V}$, $I_C = 6.5\text{ A}$ $R_G = 1.0\text{ k}\Omega$, $R_L = 1.5\text{ }\Omega$	$T_J = 25^\circ\text{C}$	–	4.5	6.0	μSec
			$T_J = 150^\circ\text{C}$	–	5.0	6.0	

3. Pulse Test: Pulse Width $\leq 300\text{ }\mu\text{s}$, Duty Cycle $\leq 2\%$.

*Maximum Value of Characteristic across Temperature Range.

MGP15N40CL, MGB15N40CL

TYPICAL ELECTRICAL CHARACTERISTICS (unless otherwise noted)

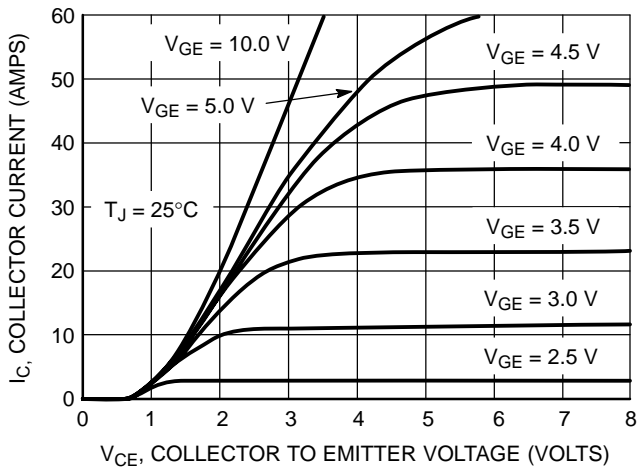

Figure 1. Output Characteristics

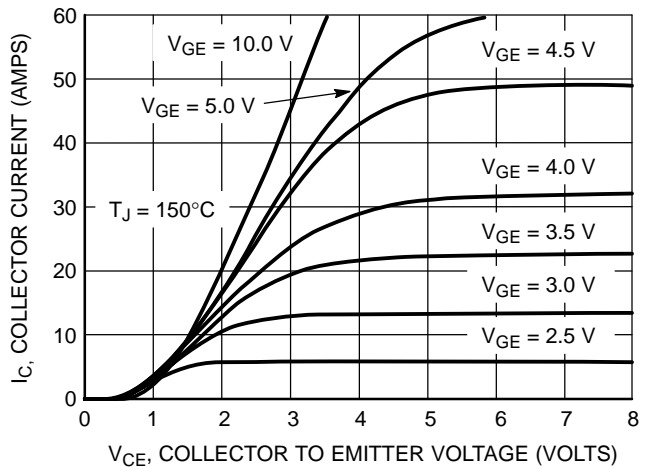

Figure 2. Output Characteristics

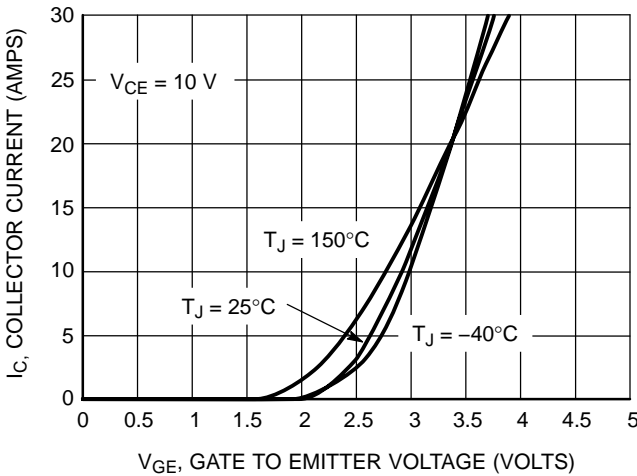

Figure 3. Transfer Characteristics

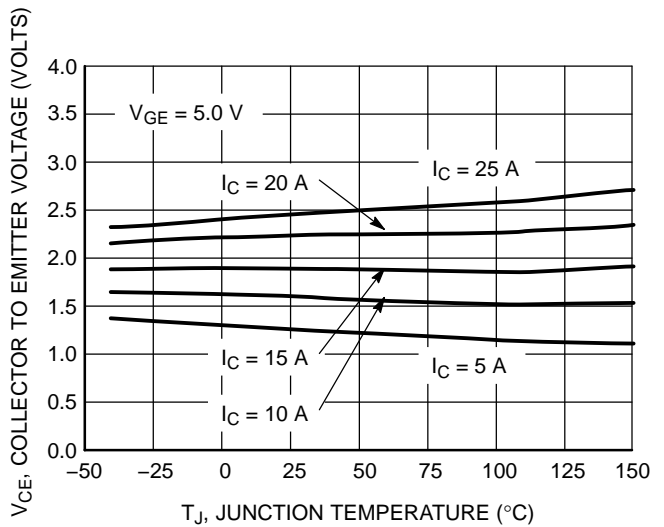

Figure 4. Collector-to-Emitter Saturation Voltage vs. Junction Temperature

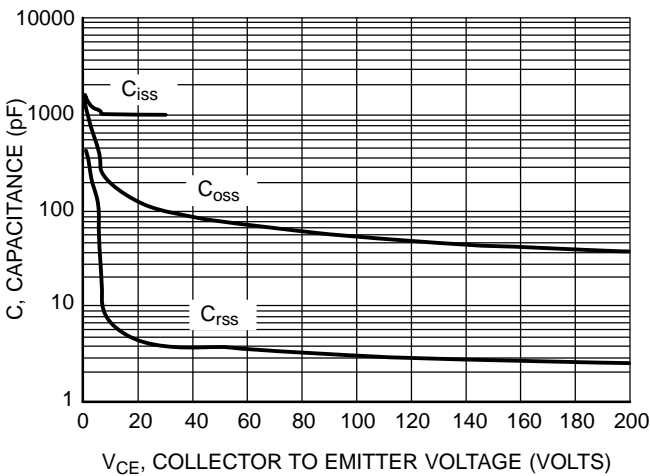

Figure 5. Capacitance Variation

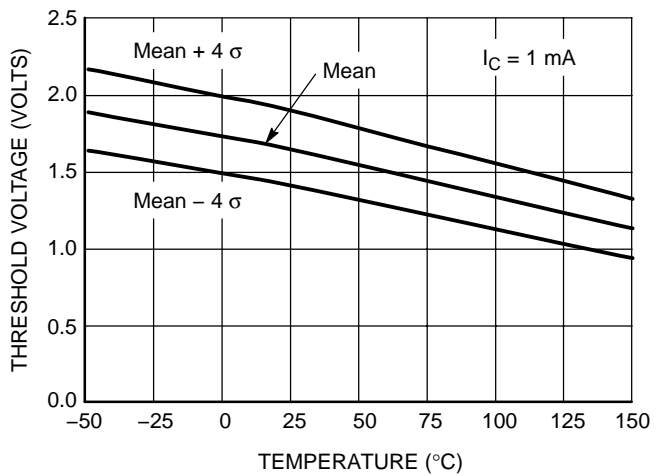

Figure 6. Threshold Voltage vs. Temperature

MGP15N40CL, MGB15N40CL

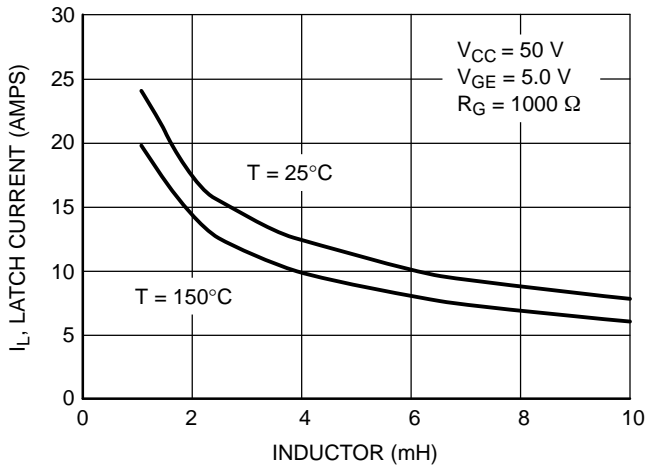

Figure 7. Minimum Open Secondary Latch Current vs. Inductor

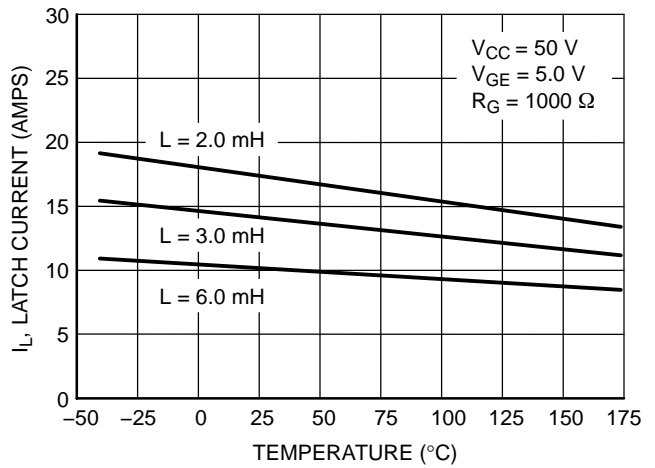

Figure 8. Minimum Open Secondary Latch Current vs. Temperature

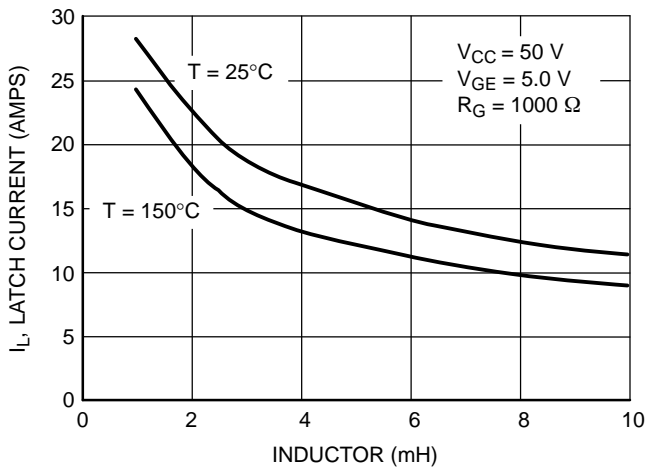

Figure 9. Typical Open Secondary Latch Current vs. Inductor

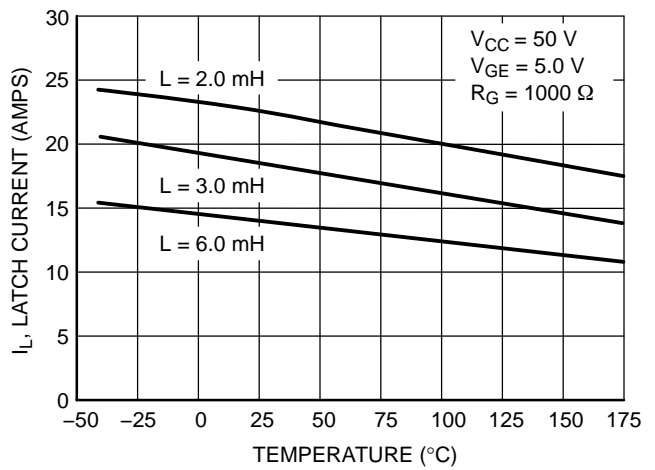

Figure 10. Typical Open Secondary Latch Current vs. Temperature

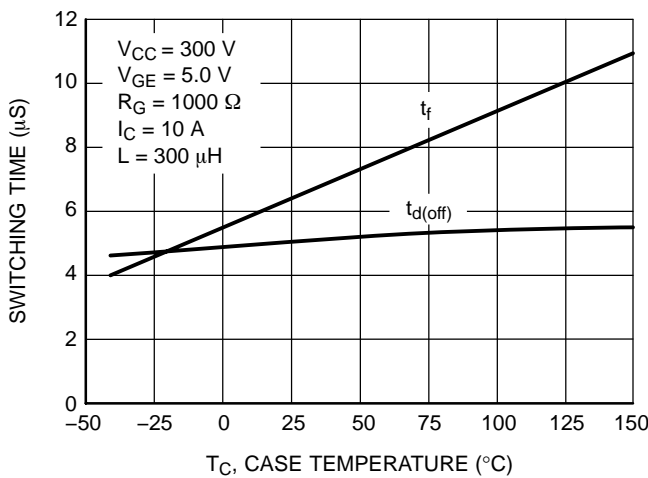

Figure 11. Switching Speed vs. Case Temperature

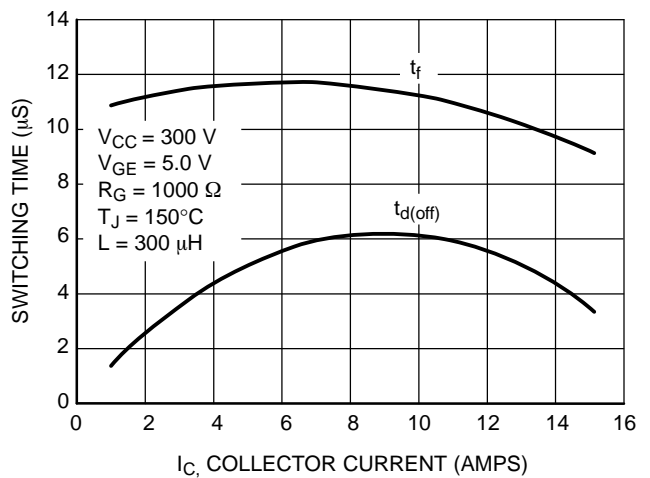

Figure 12. Switching Speed vs. Collector Current

MGP15N40CL, MGB15N40CL

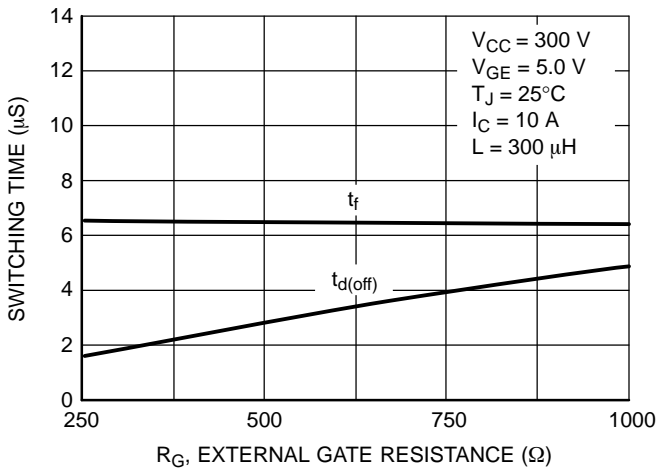

Figure 13. Switching Speed vs. External Gate Resistance

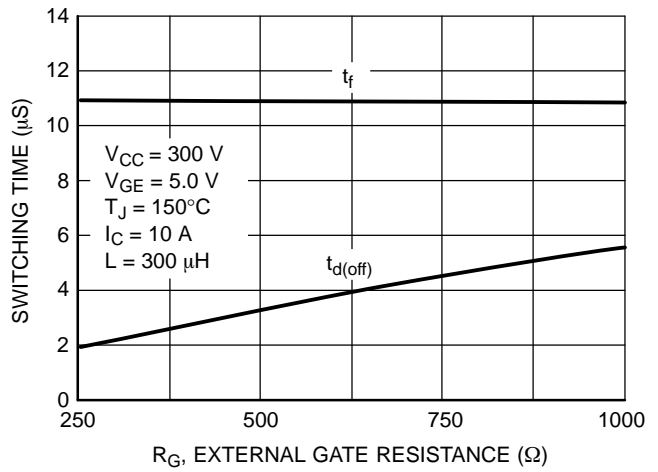

Figure 14. Switching Speed vs. External Gate Resistance

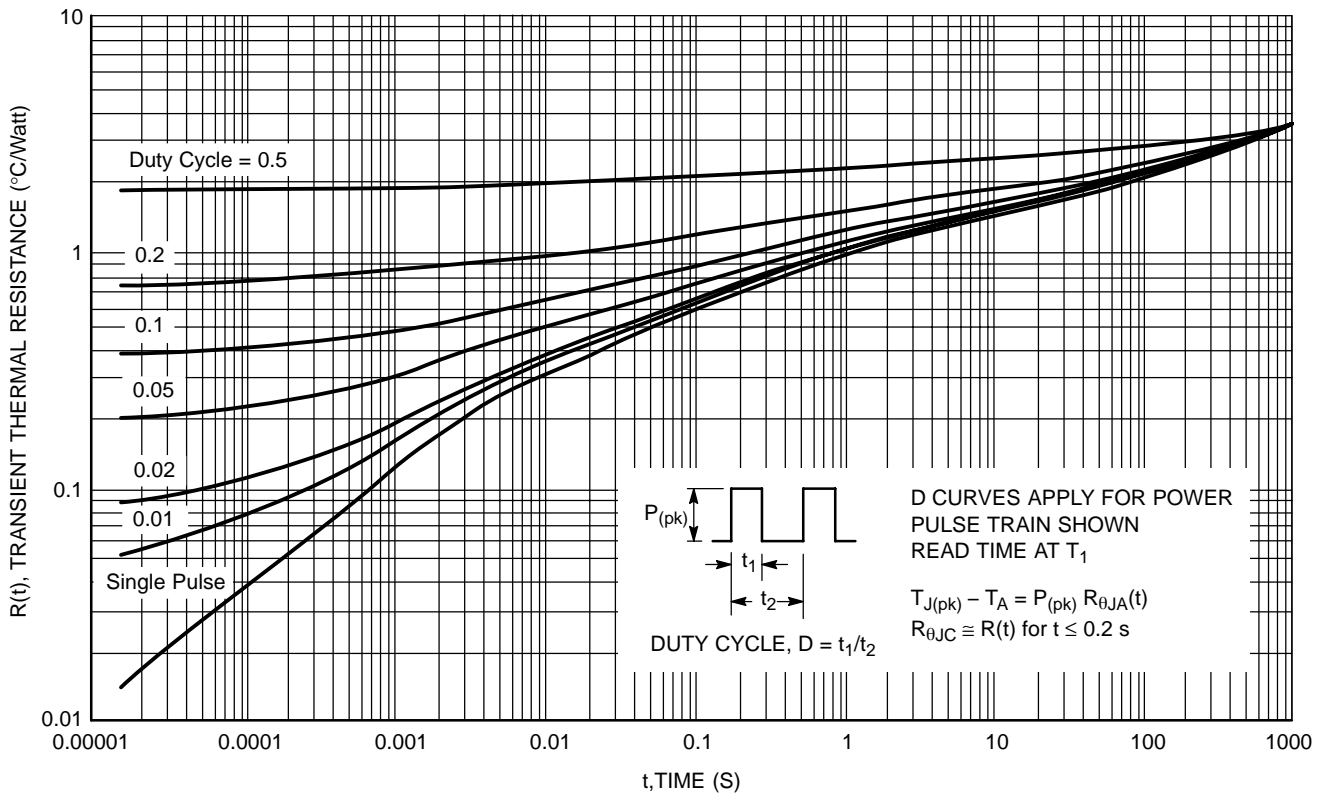

Figure 15. Transient Thermal Resistance (Non-normalized Junction-to-Ambient mounted on fixture in Figure 16)

MGP15N40CL, MGB15N40CL

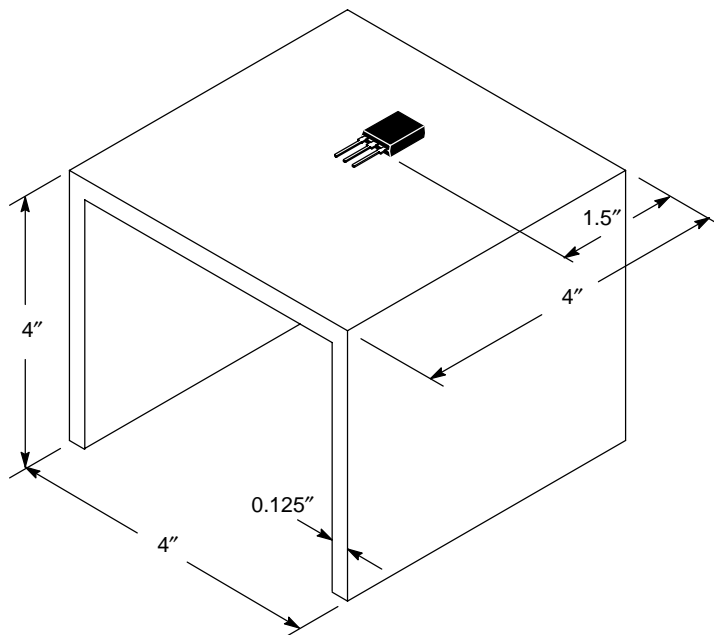

Figure 16. Test Fixture for Transient Thermal Curve
(48 square inches of 1/8" thick aluminum)

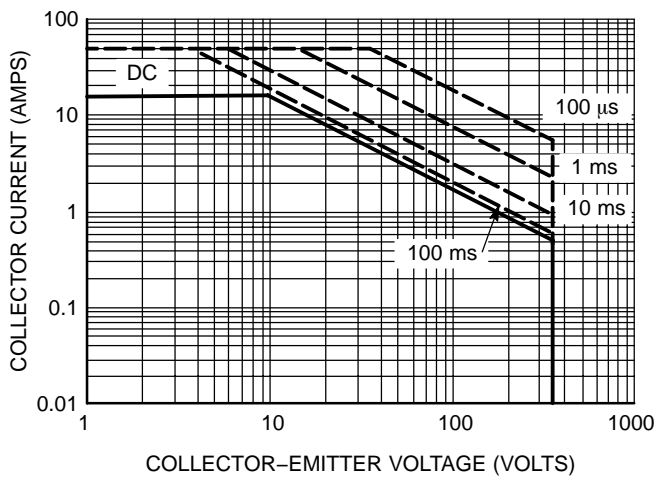

Figure 17. Single Pulse Safe Operating Area
(Mounted on an Infinite Heatsink at $T_C = 25^\circ\text{C}$)

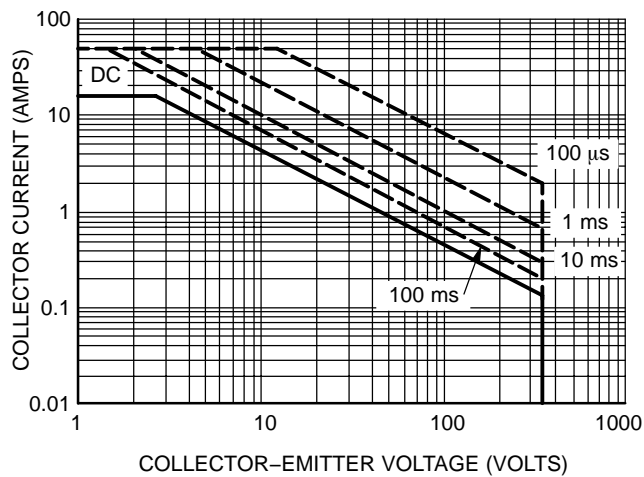
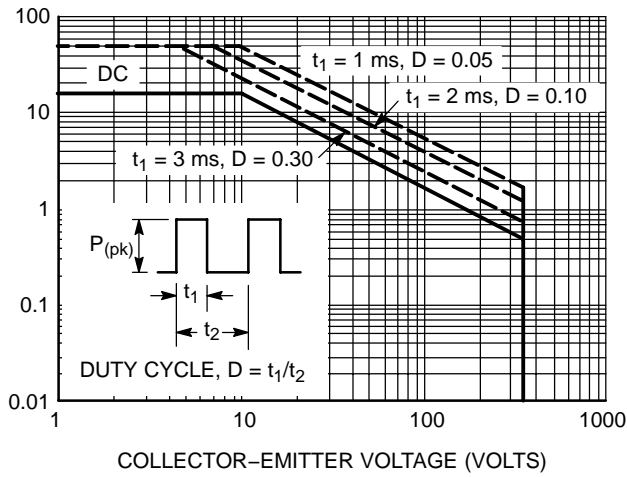
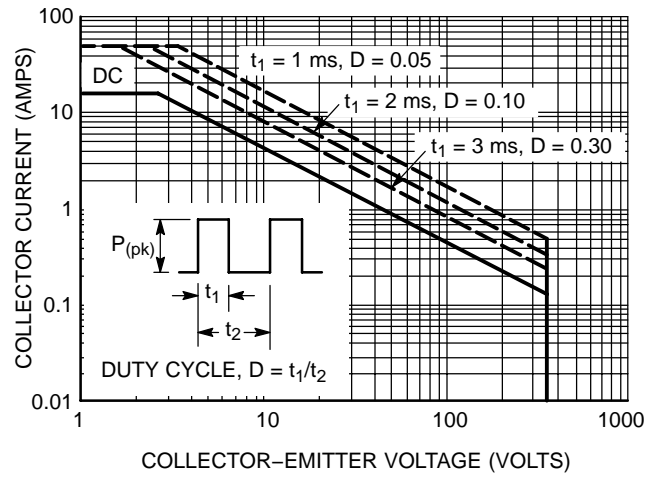

Figure 18. Single Pulse Safe Operating Area
(Mounted on an Infinite Heatsink at $T_C = 125^\circ\text{C}$)

MGP15N40CL, MGB15N40CL



**Figure 19. Pulse Train Safe Operating Area
(Mounted on an Infinite Heatsink at $T_C = 25^\circ\text{C}$)**



**Figure 20. Pulse Train Safe Operating Area
(Mounted on an Infinite Heatsink at $T_C = 125^\circ\text{C}$)**

ORDERING INFORMATION

Device	Package	Shipping [†]
MGP15N40CL	TO-220AB	50 Units / Rail
MGP15N40CLG	TO-220AB (Pb-Free)	
MGB15N40CLT4	D2PAK	800 / Tape & Reel

[†]For information on tape and reel specifications, including part orientation and tape sizes, please refer to our Tape and Reel Packaging Specifications Brochure, BRD8011/D.

MGP15N40CL, MGB15N40CL

PACKAGE DIMENSIONS

D²PAK 3
CASE 418B-04
ISSUE J

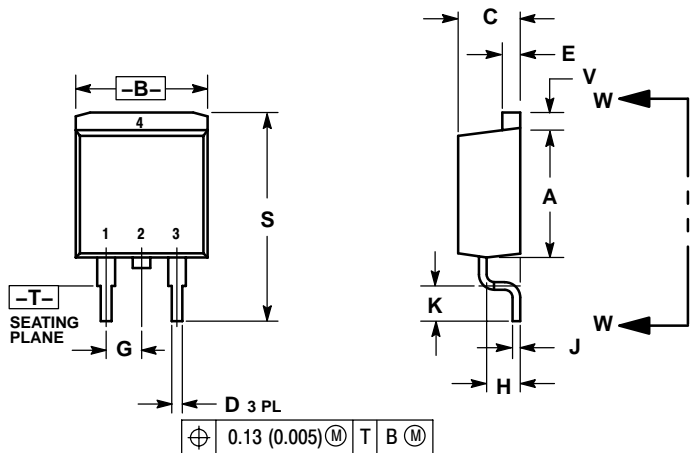

- NOTES:
1. DIMENSIONING AND TOLERANCING PER ANSI Y14.5M, 1982.
2. CONTROLLING DIMENSION: INCH.
3. 418B-01 THRU 418B-03 OBSOLETE, NEW STANDARD 418B-04.

DIM	INCHES		MILLIMETERS	
	MIN	MAX	MIN	MAX
A	0.340	0.380	8.64	9.65
B	0.380	0.405	9.65	10.29
C	0.160	0.190	4.06	4.83
D	0.020	0.035	0.51	0.89
E	0.045	0.055	1.14	1.40
F	0.310	0.350	7.87	8.89
G	0.100 BSC		2.54 BSC	
H	0.080	0.110	2.03	2.79
J	0.018	0.025	0.46	0.64
K	0.090	0.110	2.29	2.79
L	0.052	0.072	1.32	1.83
M	0.280	0.320	7.11	8.13
N	0.197 REF		5.00 REF	
P	0.079 REF		2.00 REF	
R	0.039 REF		0.99 REF	
S	0.575	0.625	14.60	15.88
V	0.045	0.055	1.14	1.40

- STYLE 4:
PIN 1. GATE
2. COLLECTOR
3. EMITTER
4. COLLECTOR

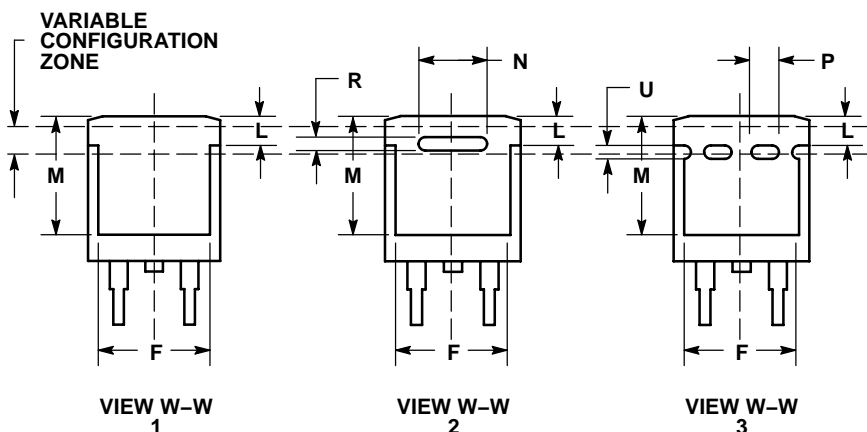

SOLDERING FOOTPRINT*

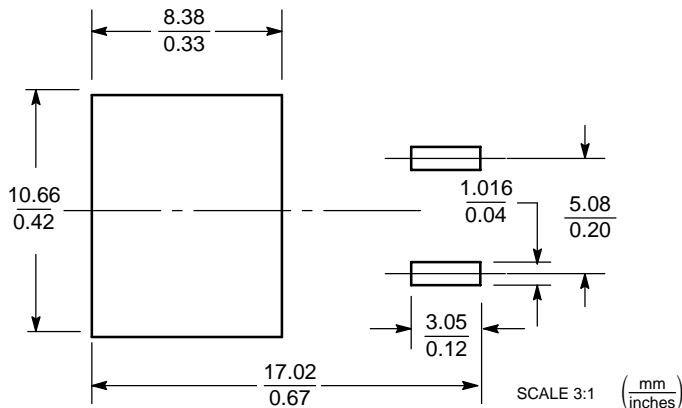

*For additional information on our Pb-Free strategy and soldering details, please download the ON Semiconductor Soldering and Mounting Techniques Reference Manual, SOLDERRM/D.

MGP15N40CL, MGB15N40CL

PACKAGE DIMENSIONS

TO-220 THREE-LEAD
TO-220AB
CASE 221A-09
ISSUE AA

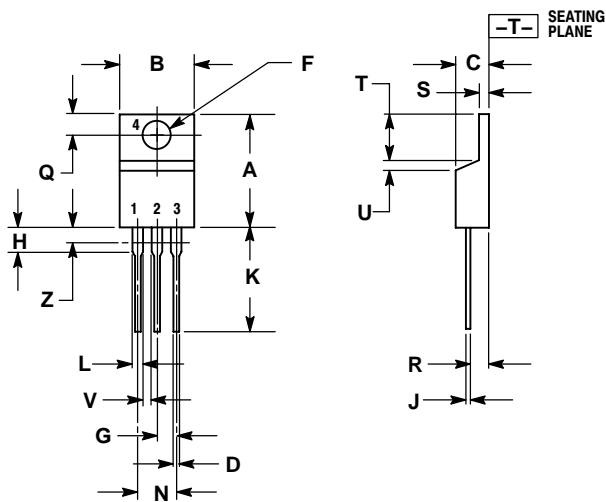

- NOTES:
1. DIMENSIONING AND TOLERANCING PER ANSI Y14.5M, 1982.
 2. CONTROLLING DIMENSION: INCH.
 3. DIMENSION Z DEFINES A ZONE WHERE ALL BODY AND LEAD IRREGULARITIES ARE ALLOWED.

DIM	INCHES		MILLIMETERS	
	MIN	MAX	MIN	MAX
A	0.570	0.620	14.48	15.75
B	0.380	0.405	9.66	10.28
C	0.160	0.190	4.07	4.82
D	0.025	0.035	0.64	0.88
F	0.142	0.147	3.61	3.73
G	0.095	0.105	2.42	2.66
H	0.110	0.155	2.80	3.93
J	0.018	0.025	0.46	0.64
K	0.500	0.562	12.70	14.27
L	0.045	0.060	1.15	1.52
N	0.190	0.210	4.83	5.33
Q	0.100	0.120	2.54	3.04
R	0.080	0.110	2.04	2.79
S	0.045	0.055	1.15	1.39
T	0.235	0.255	5.97	6.47
U	0.000	0.050	0.00	1.27
V	0.045	---	1.15	---
Z	---	0.080	---	2.04

STYLE 9:

- PIN 1. GATE
2. COLLECTOR
3. EMITTER
4. COLLECTOR

ON Semiconductor and are registered trademarks of Semiconductor Components Industries, LLC (SCILLC). SCILLC reserves the right to make changes without further notice to any products herein. SCILLC makes no warranty, representation or guarantee regarding the suitability of its products for any particular purpose, nor does SCILLC assume any liability arising out of the application or use of any product or circuit, and specifically disclaims any and all liability, including without limitation special, consequential or incidental damages. "Typical" parameters which may be provided in SCILLC data sheets and/or specifications can and do vary in different applications and actual performance may vary over time. All operating parameters, including "Typicals" must be validated for each customer application by customer's technical experts. SCILLC does not convey any license under its patent rights nor the rights of others. SCILLC products are not designed, intended, or authorized for use as components in systems intended for surgical implant into the body, or other applications intended to support or sustain life, or for any other application in which the failure of the SCILLC product could create a situation where personal injury or death may occur. Should Buyer purchase or use SCILLC products for any such unintended or unauthorized application, Buyer shall indemnify and hold SCILLC and its officers, employees, subsidiaries, affiliates, and distributors harmless against all claims, costs, damages, and expenses, and reasonable attorney fees arising out of, directly or indirectly, any claim of personal injury or death associated with such unintended or unauthorized use, even if such claim alleges that SCILLC was negligent regarding the design or manufacture of the part. SCILLC is an Equal Opportunity/Affirmative Action Employer. This literature is subject to all applicable copyright laws and is not for resale in any manner.

PUBLICATION ORDERING INFORMATION

LITERATURE FULFILLMENT:
Literature Distribution Center for ON Semiconductor
P.O. Box 61312, Phoenix, Arizona 85082-1312 USA
Phone: 480-829-7710 or 800-344-3860 Toll Free USA/Canada
Fax: 480-829-7709 or 800-344-3867 Toll Free USA/Canada
Email: orderlit@onsemi.com

N. American Technical Support: 800-282-9855 Toll Free
USA/Canada

Japan: ON Semiconductor, Japan Customer Focus Center
2-9-1 Kamimeguro, Meguro-ku, Tokyo, Japan 153-0051
Phone: 81-3-5773-3850

ON Semiconductor Website: <http://onsemi.com>

Order Literature: <http://www.onsemi.com/litorder>

For additional information, please contact your local Sales Representative.

MGP15N40CL/D